

TECHNICAL MANUAL

STEEL SCAFFOLDING

Safe Cuplock Scaffolding

We supply multi-purpose steel Cuplock scaffold for general access and supporting vertical loads in structural & Civil work with all ancillary products as per safety standard requirement. We provide Cuplock staircase towers and mobile towers.



Customized, Mobile Tower with Staircase & if any other

Components:

1. Cuplock Vertical / Standard

Made from Steel Pipe 40NB with fix bottom Cups & Rotating forged top Cups which having provision of Locking pins to locate the Ledger at every 0.5mtr or 1mtr Height Spacing.

- 0.5mtr with 1cup
- 1.0mtr with 1cup or 2cups
- 1.5mtr with 2cups or 3cups
- 2.0mtr with 2cups or 4cups
- 2.5mtr with 3cups or 5cups
- 3.0mtr with 3cups or 6cup

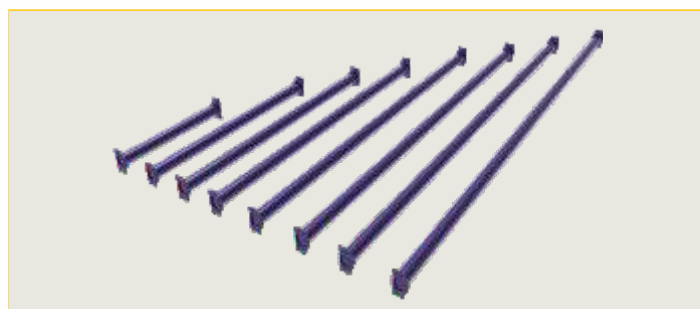
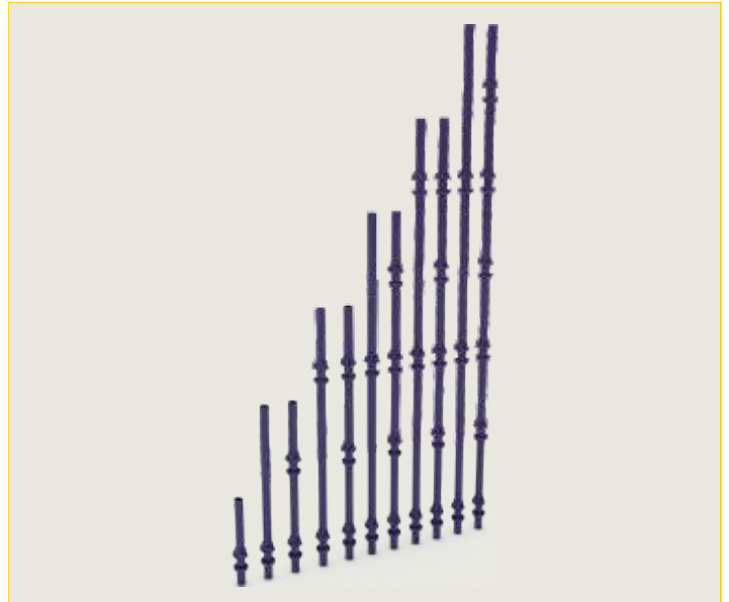

2. Cuplock Ledger / Horizontal - Made from Steel Pipe 40NB with Forged Blade Ends to locate in between cup joints.

0.6mtr / 1mtr / 1.2mtr / 1.25mtr / 1.5mtr /

3. Cuplock Spigot / Joint Pin - Made from Steel Tubes which get insert into the Vertical pipe & fix with bolt to hold vertical in position by resisting minor lateral forces.
with 38mm OD Pipe - 200mm/300mm Height

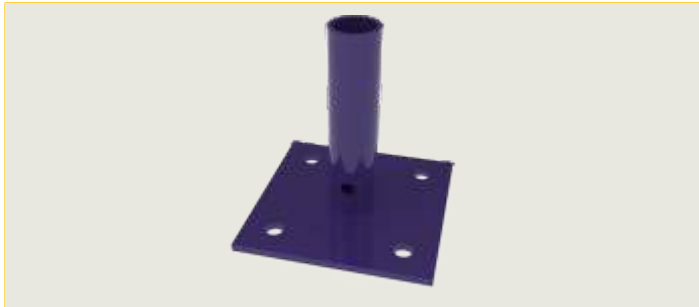

4. Fix Base Plate - Use at bottom of Vertical to distribute Load and avoid end damage.
34mm OD Pipe / 38mm OD Pipe x 150mm Height

5. Adjustable Base Jack - Use to secure & Level the base of vertical with provision of Threaded Jack & Standard Forged Nut Height Adjustment.
with pipe 38mm/ 32mm OD-Jack Pipe sizes- 350mm/500mm/600mm Height

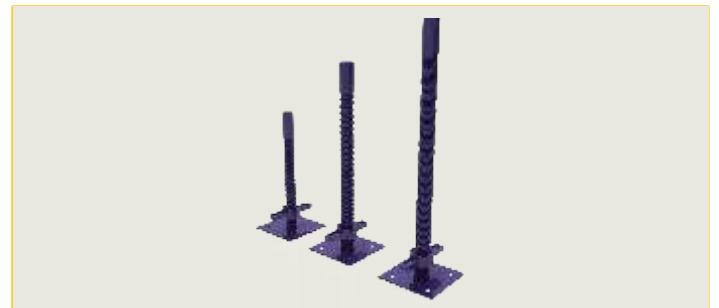

7. Four Way Head - Use at Top of Vertical to rest the Wooden Runner or MS Beam in two Way under Shuttering & other Load taking structure Applications.
with pipe 38mm OD Spacing 100 mm/200mm- Jack Pipe Sizes 350mm/ 500mm/600mm Height



6. Adjustable U Head / U Head Jack - Use at Top of Vertical to rest the Wooden Runner or MS Beam Shuttering & other Load taking structure Applications.
with pipe 38mm OD/ 32mm OD- Spacing 100 mm/200mm- Jack Pipe Sizes 350mm/ 500mm/600mm Height



8. Drop Head Unit - Specialized unique product use at top of Scaffold member for Ceiling Formwork to lower from its position.

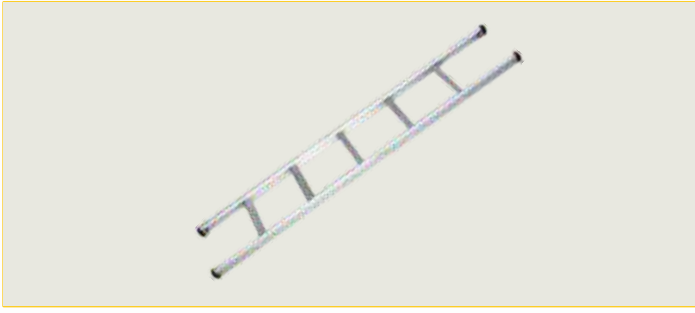

9. Aluminum Wall Support Ladder –
Easy to locate on scaffold pipe with Clamp in vertical & Incline position
3mtr/ 4mtr /5mtr/6mtr Height

10. MS Ladder with Pipe 48mm OD – Easy to locate on scaffold pipe with clamp in Vertical position
2mtr/ 3mtr/4mtr/5mtr/6mtr Height

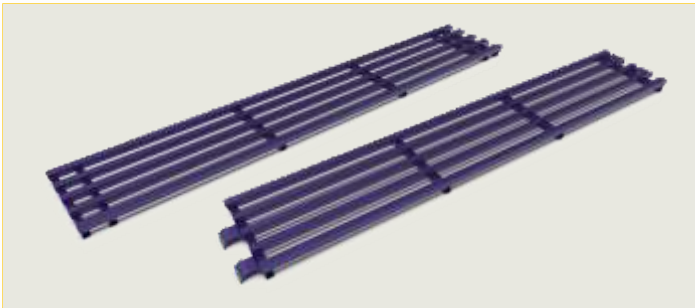
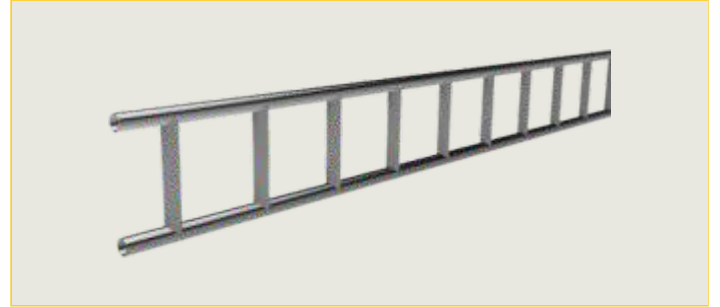

11. MS Jalli with 25 x 25mm Square Pipe –
Made with Square Pipe 25mm with & Without Hooks
- 1mtr /1.25mtr/1.5mtr /2.0mtr/2.1mtr /2.5mtr /3mtr

12. MS Plain Platform – Its durable platform made with Steel Sheet with require safe working load.
GI & Painted - with Hooks & Without Hooks –
W 0.225mtr/0.3mtr, H 38mm,
L 1mtr/1.2mtr/1.25mtr/1.5mtr/1.8mtr/2mtr/ 2.5mtr/ 3mtr

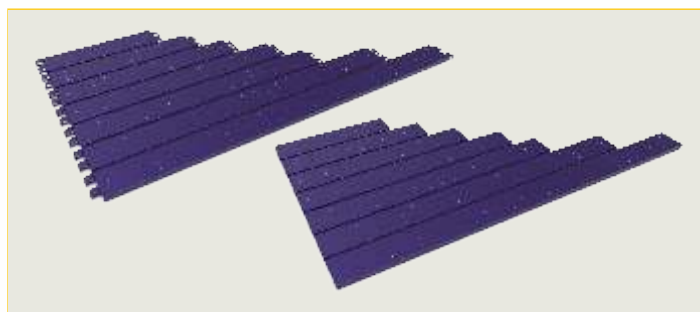
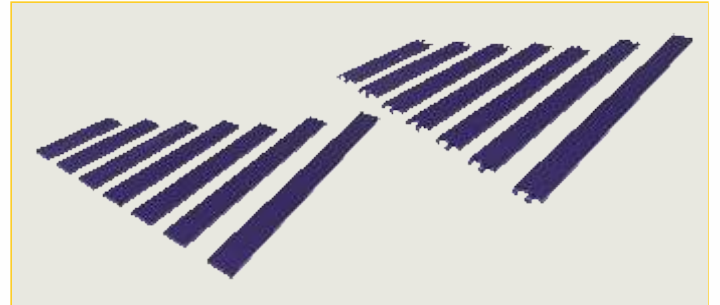

13. MS Antiskid Platform – It incorporate a non- skid perforated Surface for Slip Resistance
GI & Painted with Hooks & Without Hooks -
W 0.225mtr /0.3mtr, H 38mm, L 1mtr /1.2mtr/1.25mtr/1.5mtr/1.8mtr/2mtr/2.5mtr/ 3mtr

14. Cuplock Toe board 150mm – It prevents the objects from falling or rolling over the working platform.
MS / Wooden – Painted - with Clamps & Without Clamps - 1mtr / 1.2mtr / 1.25mtr / 1.5mtr/1.8mtr/2mtr/2.5mtr/3mtr

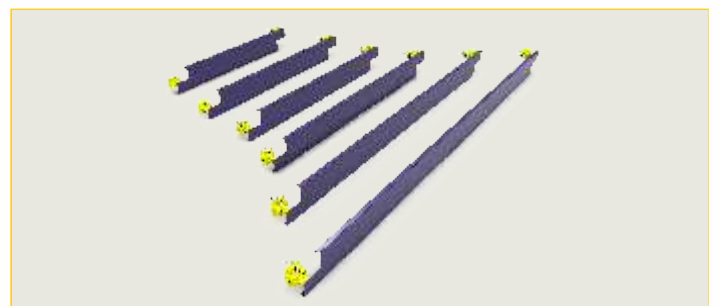

15. Cuplock Cantilever Bracket - This Specially adapted in scaffold System to Extend the Platform Length outside the Scaffold Tower.

Painted - 0.525mtr/0.75mtr/1mtr/1.3mtr

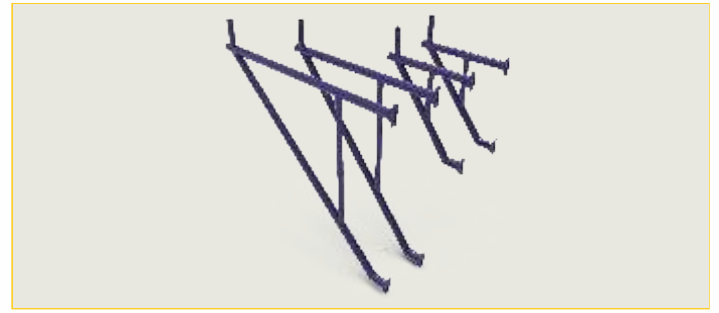

16. MS Transom - Made with steel Tube with U hook at both ends to support & resist the platform working Load.

1mtr / 1.25mtr / 1.5mtr / 1.8mtr / 2.0mtr / 2.5mtr

17. Sole Board 38mm - It use to distribute the Load from a Base Plate to the Ground MS / Wooden - Painted / Bare- 300mm x300mm or 150mm x 3mtr



18. MS Guardrail Jaali 1mtr - Made with MS Full Fall Protection

with Clamps/ Ledger Ends- Painted / GI- 1mtr/1.2mtr/1.5mtr/2mtr/2.5m

19. Caster Wheel - Wheel Made of Material Polyurethane / Polyprolines / Nylon/Rubber with Threaded Jack Pipe & Swivel Type. Use for Mobile Scaffold Tower. Size 8'/6' - With/Without Brake

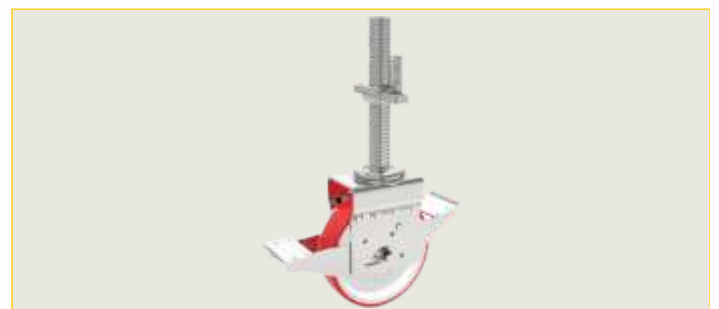

20. MS Staircase with Handrail Support -

Painted - Made with Side Pipe Rail and Antiskid Steps with handrail for safely climbing on height. Its with Man Climbing or Man & Material Climbing Type as per Staircase Width. Size in width 425/ 675/1000 with 2mtr Lift Height

Safe Pipe & Coupler Scaffold:

We supply multi-purpose steel Cuplock scaffold for general access and supporting vertical loads in structural & Civil work with all ancillary products as per safety standard requirement. We provide Cuplock staircase towers and mobile towers.



Components:

1) 40NB (48.3mm OD) Pipe MS/ Painted/ GI -

Sizes - 1mtr/ 2mtr/ 3mtr /4mtr /5mtr /6mtr (Used as Vertical, Horizontal, Face Bracing, Plan Bracing, Anchor, Stabilizer)

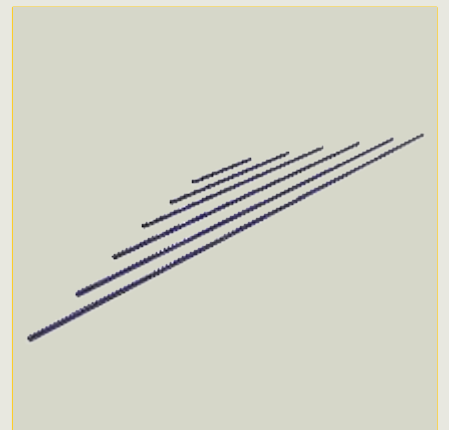

2) Sheet Metal Pressed Fittings - All Types (Electroplated)

1. Right-angle / Fix / Double Coupler for

40NB/40NB Pipe
40NB/50NB Pipe
50NB/50NB Pipe





2. Swivel / Movable / Round Coupler for 40NB / 40NB Pipe
40NB/ 50NB Pipe
50NB/ 50NB Pipe



3. Put log / Single Coupler for 40NB Pipe



4. Sleeve / Box Coupler for 40NB Pipe



5. EJP Coupler



6. Board Clamp



7. Box Ladder Coupler



8. Ladder Coupler (Hook)

3) Drop Forged Fittings- All Types (Electroplated)



1. Right-angle/ Fix / Double Coupler for 40NB / 40NB Pipe
40NB/ 50NB Pipe
50NB/ 50NB Pipe



2. Swivel/ Movable/ Round Coupler for 40NB / 40NB Pipe
40NB/ 50NB Pipe
50NB/ 50NB Pipe



4. Beam / Girder Coupler for 40NB Pipe



5. Ladder Coupler



3. Put log / Single Coupler for 40NB Pipe



6. Board Coupler / Board Retaining Coupler for 38mm Height



7. Half Forger Coupler

Safe H-Frame Scaffolding

We supply frames which interconnected by cross braces in different sizes of bays with all ancillary products as per safety standard requirement. We supply H-frame staircase Tower (with both option of MS or AL Staircase and Platform) & Mobile Tower.

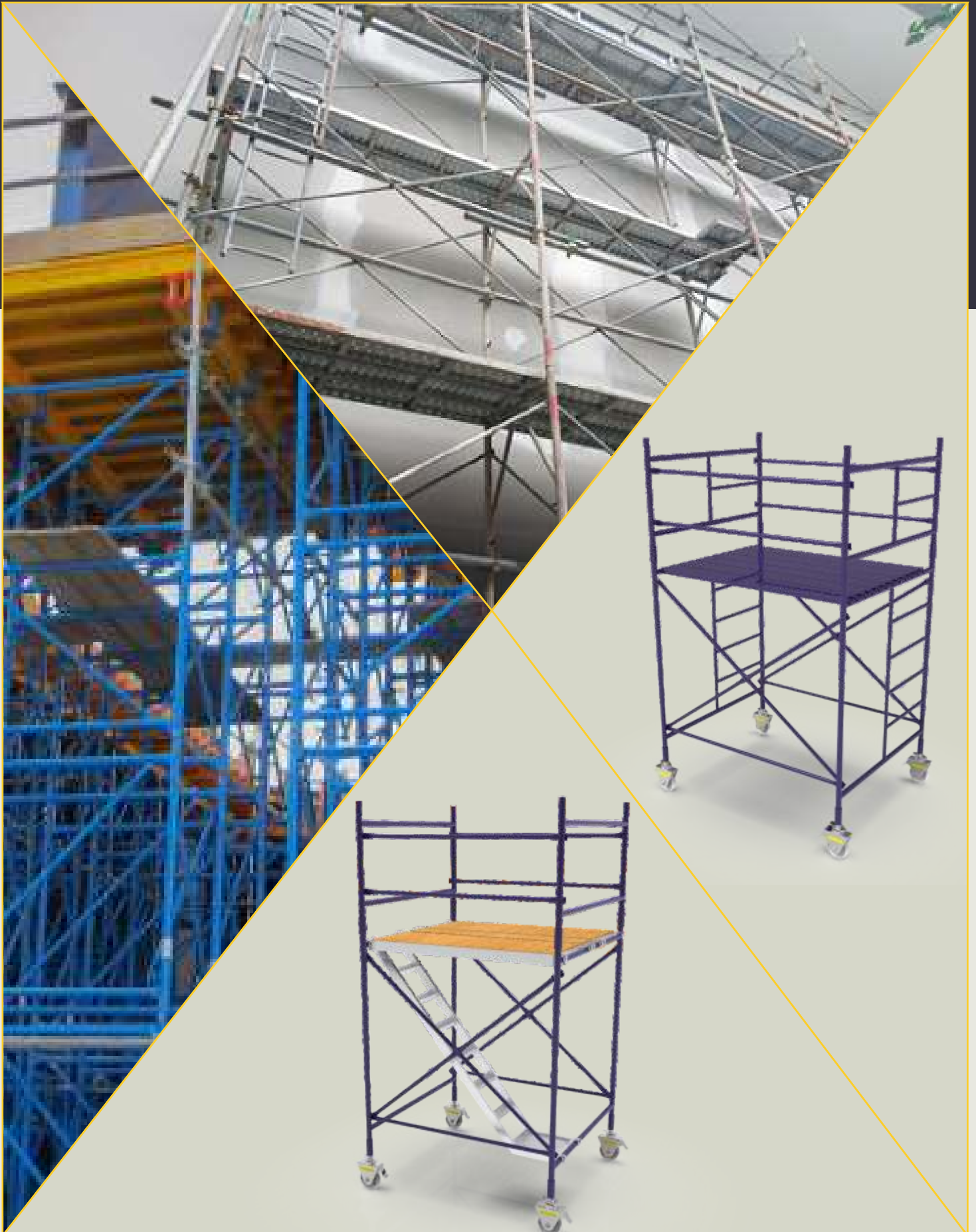

Core Components:

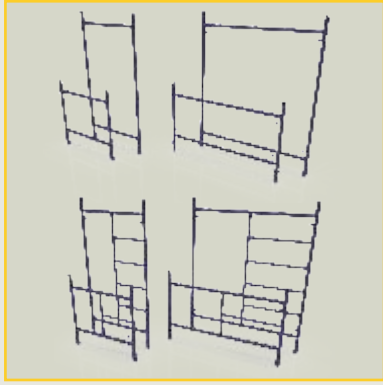

1. MS H-Frame – With & without Brace
/ with Inbuilt Vertical Ladder-
Sizes: 1mtr Width x 2mtr Height
1.6mtr Width x 2mtr Height

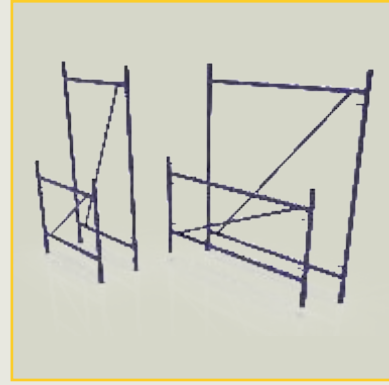

2. MS H Frame with Mid Pipe –
Sizes: 1mtr Width x 2mtr Height
1.6mtr Width x 2mtr Height



3. MS Guard rail H- frame – With &
without Brace/ with Inbuilt Vertical
Ladder
Sizes: 1mtr Width x 1mtr Height
1mtr Width x 1mtr Height
1.6mtr Width x 1mtr Height
1.6mtr Width x 1mtr Height

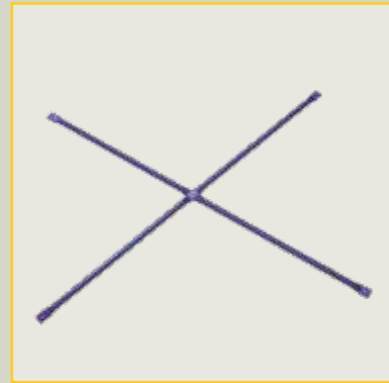

4. MS Cross Brace – with 34mm OD
Pipe For 1.5mtr /1.75mtr/ 2mtr /
2.5mtr Length

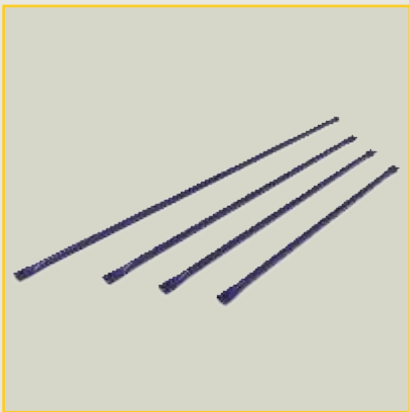

5. MS Horizontal Brace -
with 34mm OD Pipe
1.5mtr / 1.8mtr / 2mtr
Length



6. MS Diagonal Brace -
with 34mm OD Pipe
For 1.5mtr /1.8mtr/
2mtr/ 2.5mtr Length

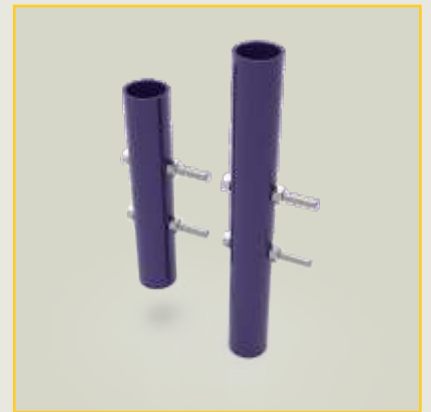

7. Spigots

Ring lock Scaffolding

We supply Ring lock Modular access Scaffolding with full range of ancillary products as per safety standard requirement.

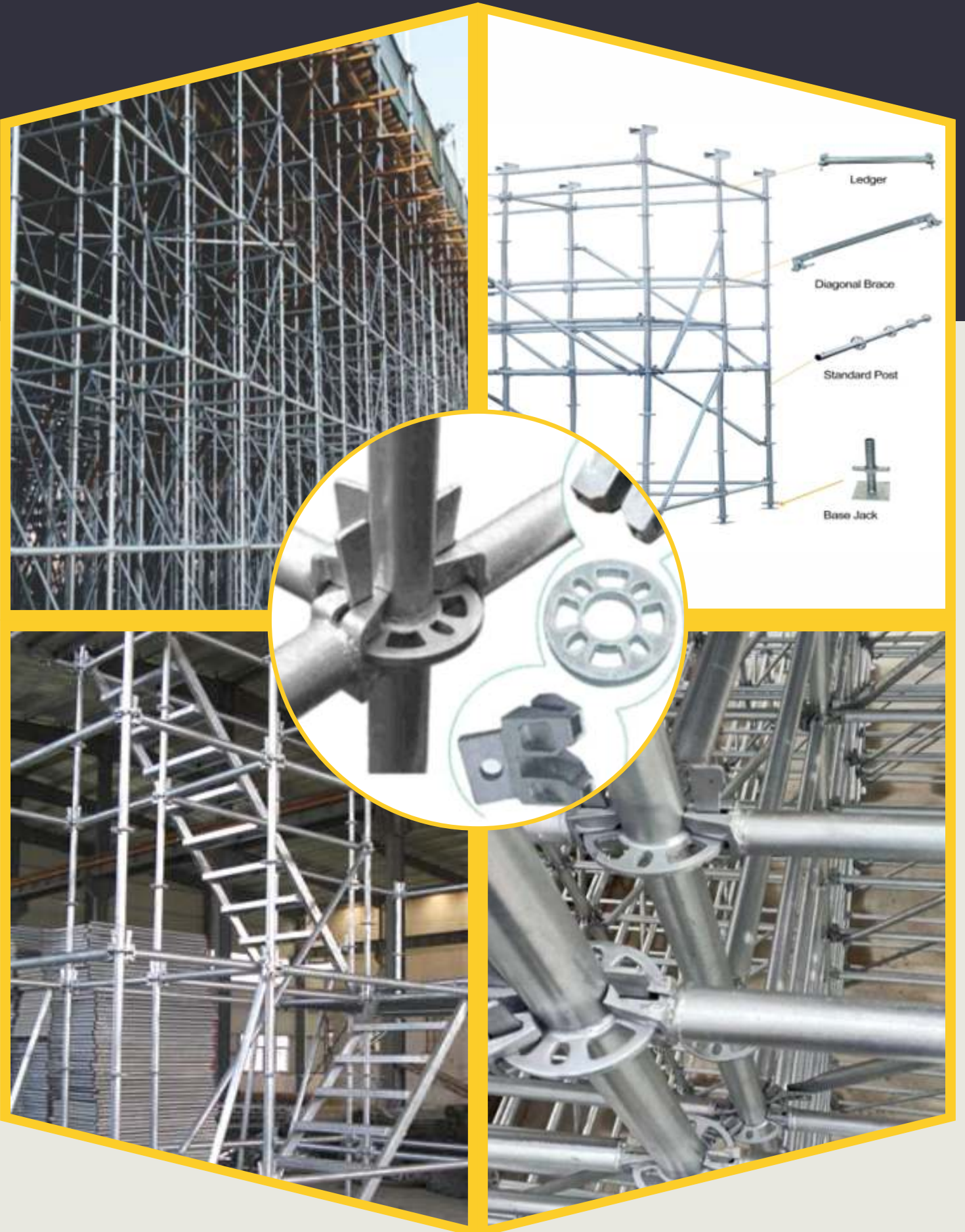

Components:



1. Ring lock Vertical / Standard- Painted/ GI

- 0.5mtr with 1Rings
- 1.0mtr with 1Ring or 2Rings
- 1.5mtr with 2Rings or 3Rings
- 2.0mtr with 2Rings or 4Rings
- 2.5mtr with 3Rings or 5Rings
- 3.0mtr with 3Rings or 6Rings



2. Ring lock Horizontal Brace - Painted / GI - 0.6mtr / 1mtr / 1.2mtr / 1.25mtr / 1.5mtr / 1.8mtr / 2.0mtr / 2.25mtr / 2.5mtr / 2.5mtr Length



3. Ring lock Face Diagonal Brace Painted/ GI - with 34mm OD Pipe For 1.5mtr / 1.8mtr / 2mtr Length



4. Ring lock Plane Diagonal Brace- Painted / GI- with 34mm OD Pipe For 1.5mtr / 1.8mtr / 2mtr Length



5. Base Collar Painted/ GI



6. Ring lock Cantilever Bracket Painted / GI - 0.525mtr / 0.75mtr / 1mtr / 1.3mtr



7. Ring lock Toe Board 150mm Painted / GI- with Clamp



8. Ring lock Bridge Ledger Painted / GI



9. Ring lock Guardrail Painted / GI



10. Special Brace Painted/GI

MS & Wooden Formwork:

We supply MS formwork which become more popular due to its strength, durability and repetitive reuse for a long period. MS shuttering offers smooth surface finish to concrete compare to wooden formwork. Instead of conventional Wooden formwork, we are supplying H-beam Formwork which easy to handle, erect and give desired result to user.

1. MS Formwork - Painted -

It is used to form the Concrete Column, Wall, Slab & Beam. There are Wall Panels which made up of sheet & Ribs fix in back support which enhance its loading capacity. All Panels Side Flanges are punch with Holes or Slots to connect each other with Nut& bolt, Wedge Pins. All Assembly is getting aligned, hold & Support with other Ancillary Products. Wall, Beam, Slab, Retaining Wall, Circular Column, Hunch Girder Beam.



Components:



1) MS Panel – Flat Panel, Corner Panel, Corner Angle, Soldier Panel Angular Hunch Panel, Circular Panel

2) Prop Jack –

Sizes:

Prop 0.6mtr + 0.6mtr	Prop 2.0mtr + 2.5mtr
Prop 0.8mtr + 0.8mtr	Prop 2.0mtr + 3.0mtr
Prop 1mtr + 1mtr	Prop 2.5mtr + 2.5mtr
Prop 1.5mtr + 1.5mtr	Prop 2.5mtr + 3.0mtr
Prop 1.5mtr + 2.0mtr	Props 3.0mtr + 3.0mtr
Prop 2.0mtr + 2.0mtr	



3) Top Adopter/ Foot Adopter –

4) Turn Buckle –

Sizes:

Turn Buckle 0.5mtr to 0.9mtr
Turn Buckle 1.1mtr to 1.5mtr
Turn Buckle 1.6mtr to 2.0mtr
Turn Buckle 2.1mtr to 2.5mtr
Turn Buckle 2.6mtr to 3.0mtr
Turn Buckle 3.1mtr to 3.5mtr



5) Hinge Adopter –

Top Hinge Adopter, Foot Hinge Adopter, Double Foot hinge Adopter

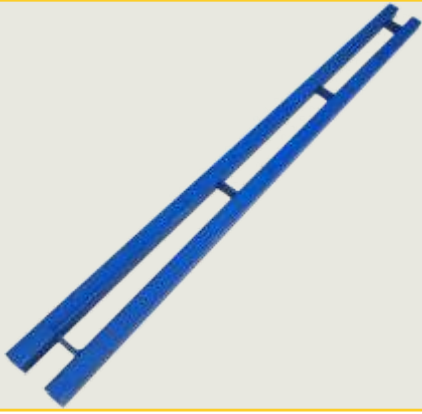

6) Waler – 75mm/ 100mm/150mm
Channel – Sizes L0.6mtr/
1mtr/1.22mtr/1.5mtr/1.8mtr
/2mtr/2.44mtr/2.5mtr/3mtr

7) Lifting Bracket –

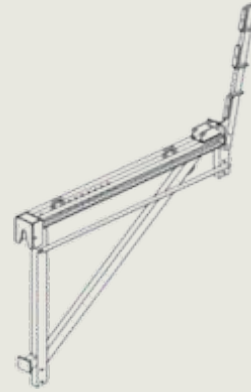

8) Light Duty Bracket for MS Panel

9) Shuttering & Centering Plate

0.3mtr x 0.9mtr
0.3mtr x 1.2mtr
0.6mtr x 0.9mtr
0.6mtr x 1.2mtr

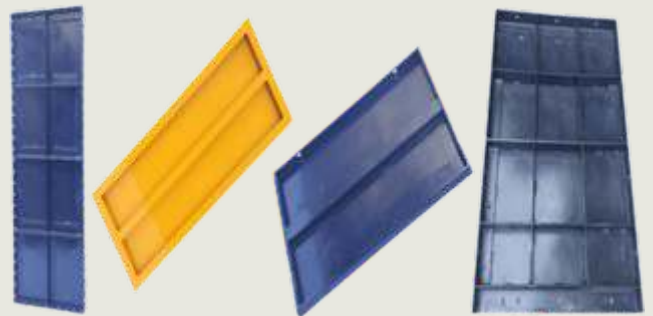

10) Adjustable Span
2mtr/ 2.5mtr/ 3mtr/ 4mtr/ 4.5mtr

Ancillary Components:

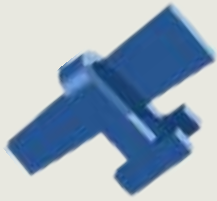

Wedge Clip



Wing Nut



Wedge Pin Bolt,



Disc Nut



Waller Straight Connector,



MS Cone

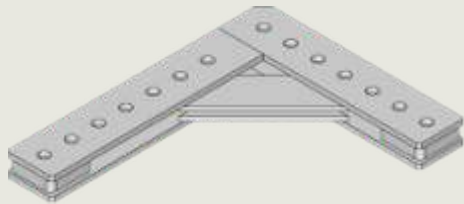

Waller Right Angle Connector,



PVC Cone



Pin bolt



Single / Double Clip for
40NB Pipe / Channel



Tie Rod



Tie Rod Nut



Washer Plate

Diagonal Connector,
PVC Pipe.

2. MS & Ply Formwork – Painted

– Wooden Ply fit in steel frame which forms concrete column, beam, Slab, Retaining wall. We can Change ply with same frame for repetitive use in respect to life cycle of both the items.

MS Frame Ply Panel

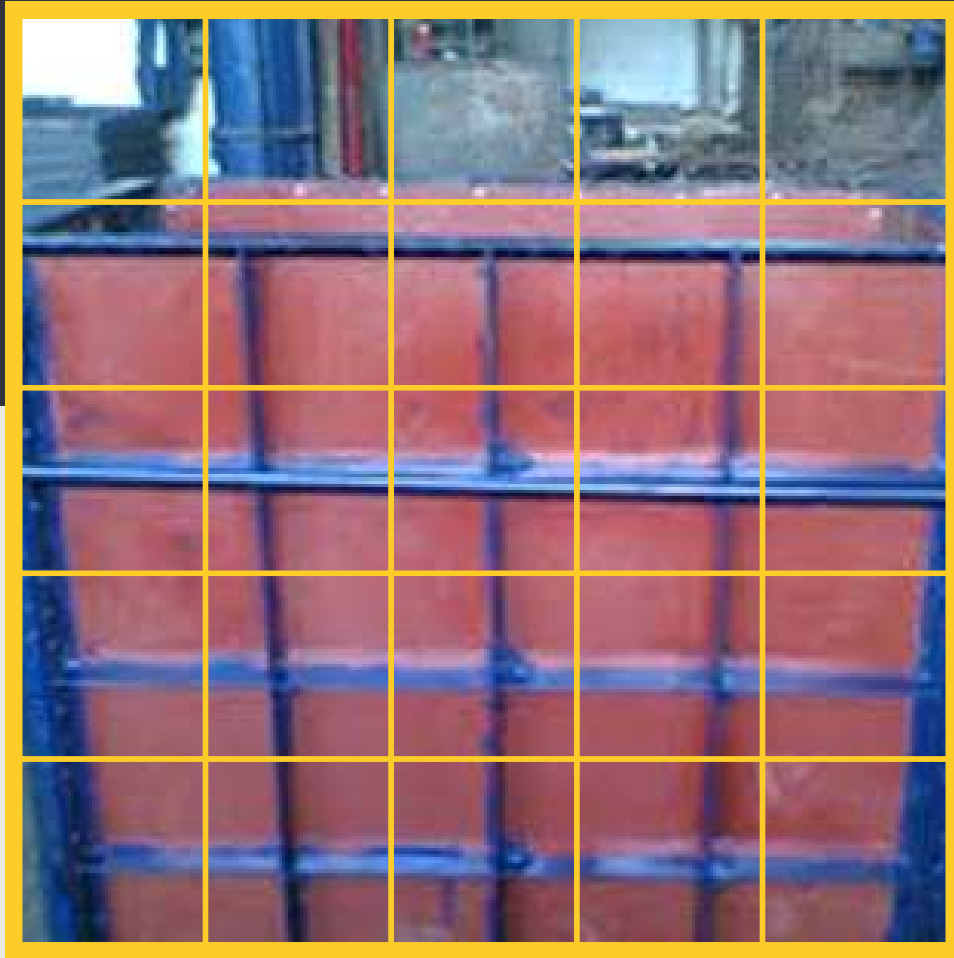

3. H-Beam Formwork – Painted-

It made with Ply & H-Beams Panel tie on Waller with Claw clamp Assembly. We provide All Main components with All ancillary products require to assemble & Work safely on height with Self Climbing System.

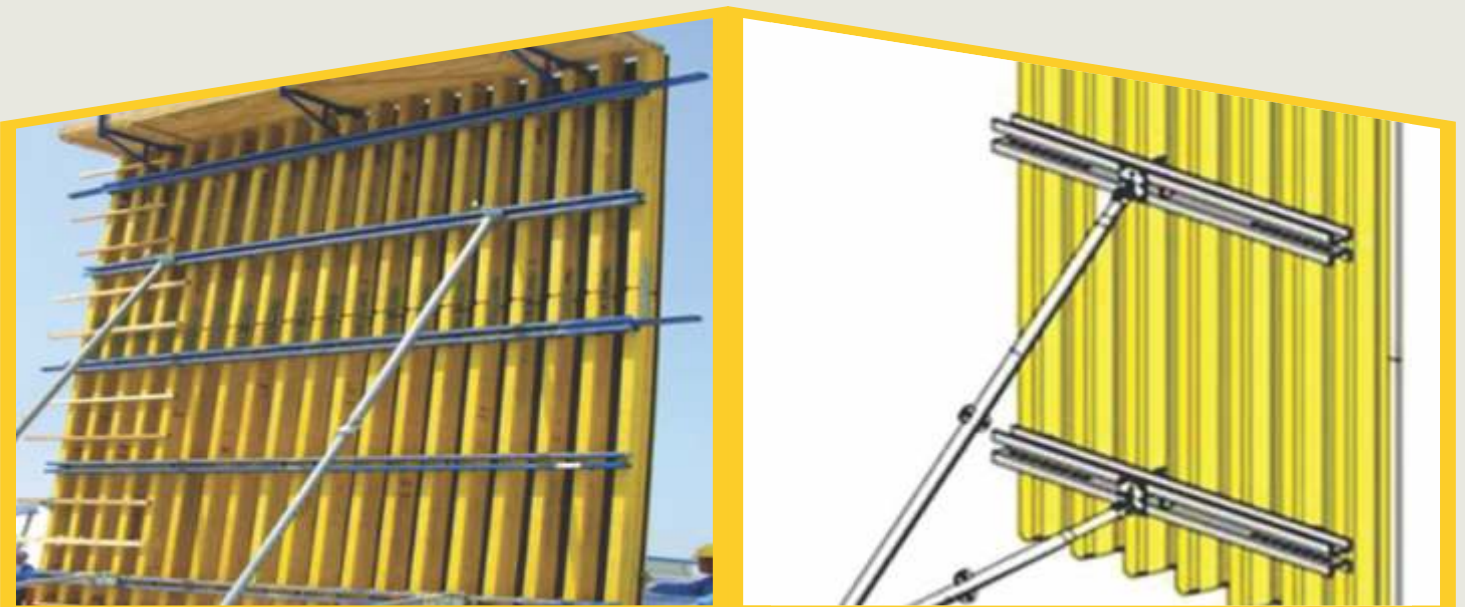

Components:

1. H Beam – 1.2mtr, 2.4mtr, 3.6mtr, 4mtr
– Painted –

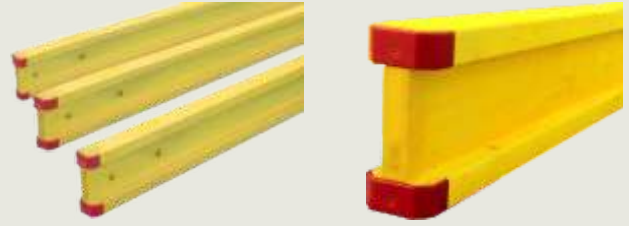

2. Plywood – 12mmT x 1.22mtr W x
2.44mtr L - Laminated Finish



3. Claw Assembly for H-beam &
Waller Tie- Painted/ GI

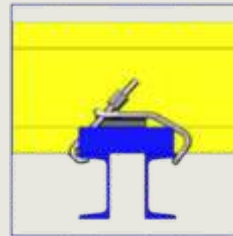

4. Climbing Lifting Bracket



5. Light duty Bracket for H-beam



6. H Beam Lifting Hook

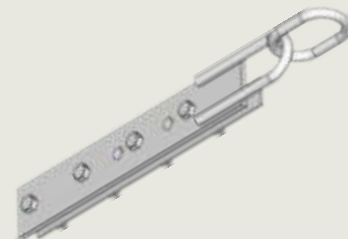

7. H Beam Connector



Aluminium Formwork

We supply Aluminium Formwork system which is widely known for easy Shifting, erection & Less cycle time of casting. This system work for High Rise Building due to repetitive use of same panel from floor to floor.



1. Aluminium Panel: Wall panel, corner panel, Deck Panel, Beam Side, Beam Bottom Panel, Kicker Panel, Rocker Angle,

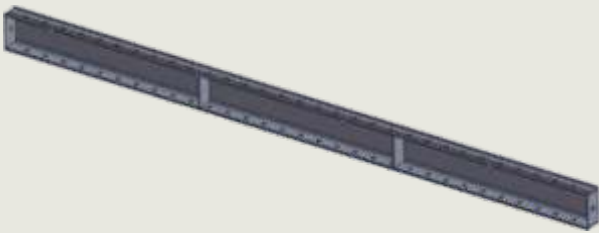
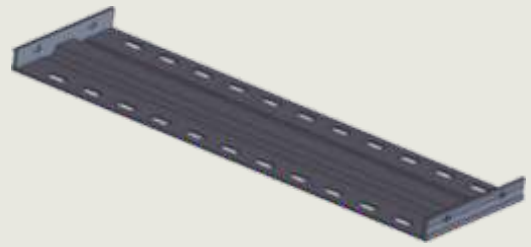
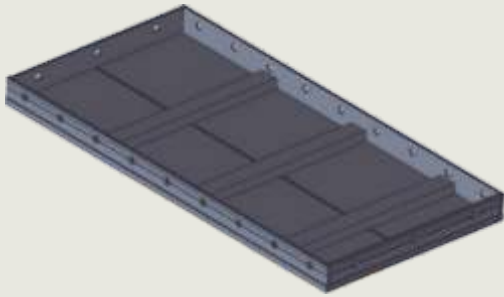
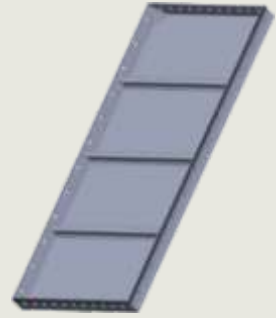
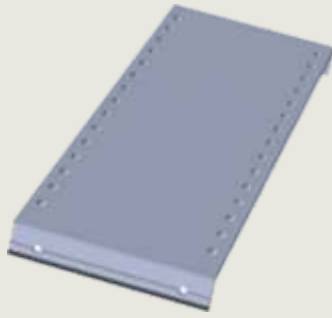
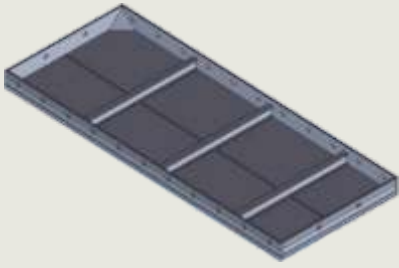

2. Accessories Panels – SL, SC, CC, IC, PH, EB, MB

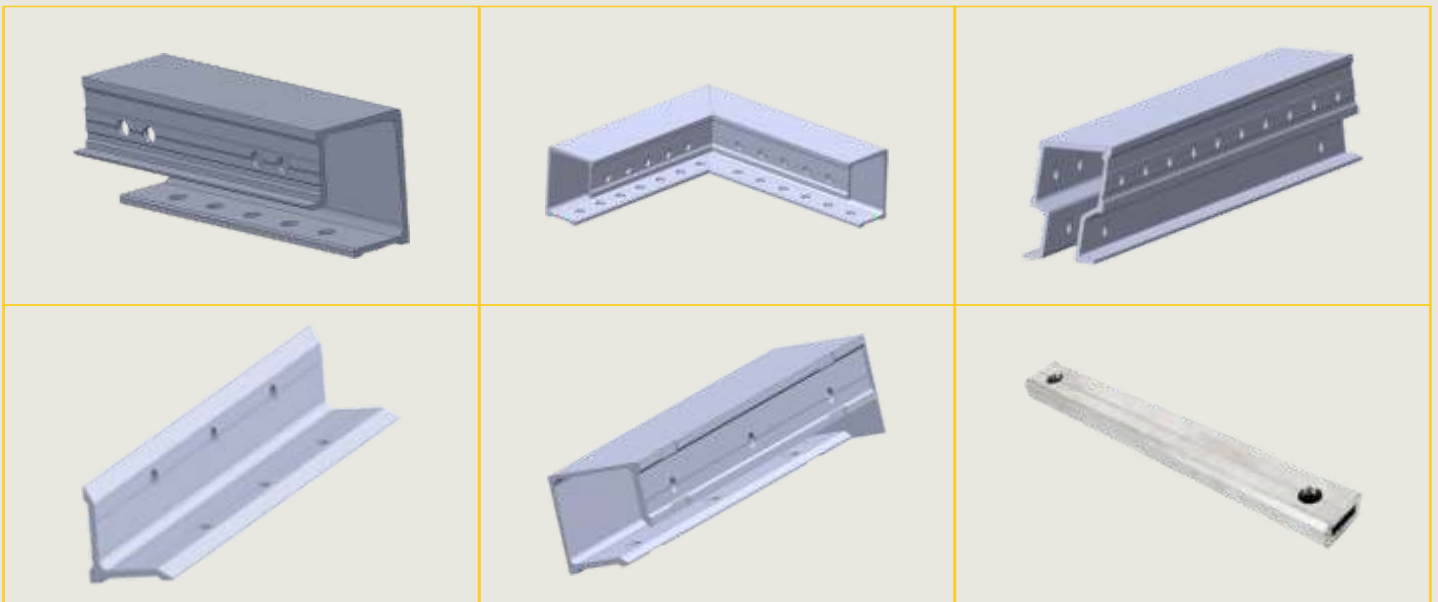

4. Ancillary components: Wedge Pin Bolt, Waller Clamp, Walkway Bracket, Wall Tie, Prop Jack

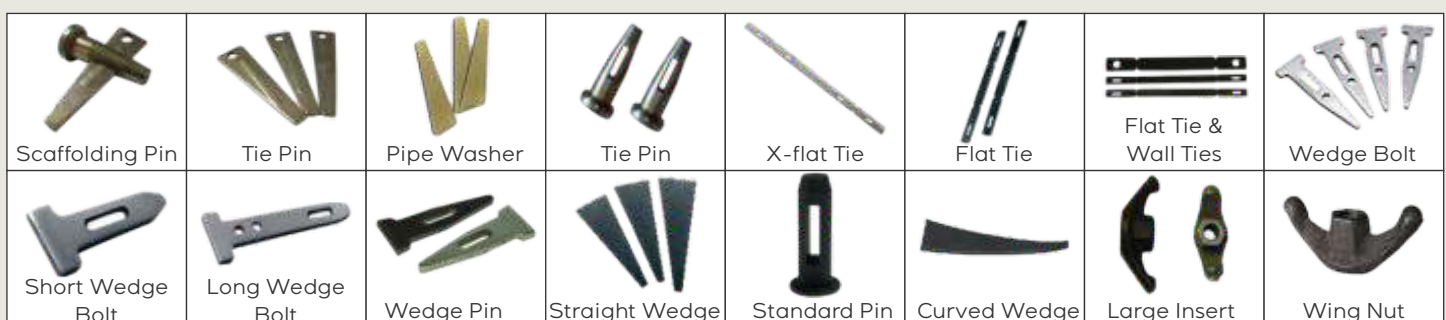

— SCHACH PRESENCE —



Delhi NCR . Mumbai . Ahmedabad . Bangalore . Kolkata . Chennai . Hyderabad . Pune . Lucknow . Coimbatore

Corporate Office:
G-401, AVJ Heights,
Sector Zeta 1,
Greater Noida - 201 306.

Mumbai Office:
13, Sanghvi Solitare, MG Road,
Carter Road No.9, Borivali (East),
Mumbai - 400 066.



Mobile: +91 74282 90741

Email: info@schachengineers.com

www.schachengineers.com